

13-19-39-59 mm

Laminati FENIX

FENIX Laminate • Stratifié FENIX • Laminado FENIX



ROSSO JAIPUR • ARPA
0751 • FENIX NTM

Caratteristiche

Features • Caractéristiques • Características

- **SUPPORTO / SUPPORT / SUPPORT / SOPORTE:**
Pannello in truciolare idrofugo P3 qualità EPF-S SP. 12-18-38-58 (*eccetto spessore 12mm)
Waterproof* chipboard panel P3 quality EPF-S TH. 12-18-38-58 (*except thickness 12mm)
Panneau de particule Hydrofuge* P3 qualité EPF-S EP. 12-18-38-58 (*sauf épaisseur 12mm)
Tablero de partículas hidrófugo* P3 calidad EPF-S ESP. 12-18-38-58 (*salvo espesor 12 mm)
- **LAMINATO SUPERIORE / FRONT LAMINATE / STRATIFIÉ RECTO / LAMINADO CARA SUPERIOR:**
FENIX NTM
- **LAMINATO INFERIORE / REAR LAMINATE / STRATIFIÉ VERSO / LAMINADO CONTRACARA:**
Controbilanciante bianco
White Counterbalance Laminate / Stratifié Blanc de contrebalancement / Laminado blanco de contracara
- **PROFILO / PROFILE / CHANT / CANTO:**
ABS Spessore 1mm
ABS Thickness 1mm
ABS Épaisseur 1mm
ABS Espesor 1 mm

Finiture

Finishes • Finitions • Acabados

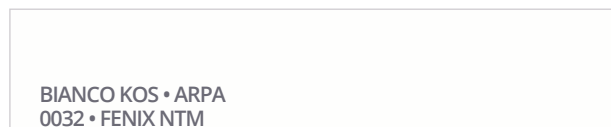
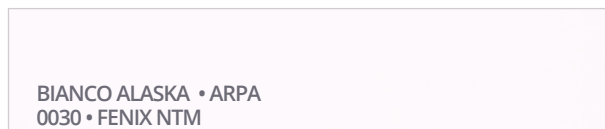
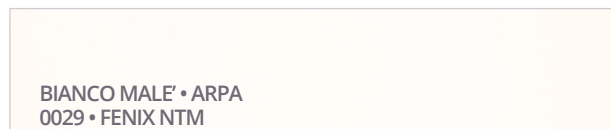

*

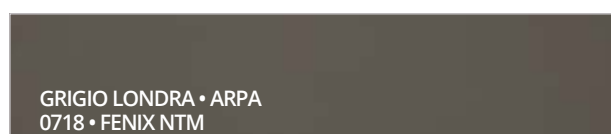
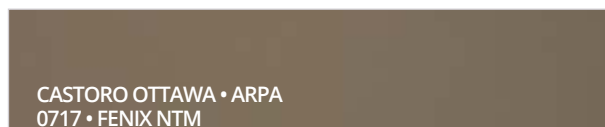

*

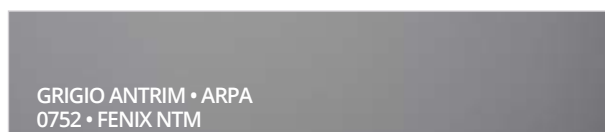
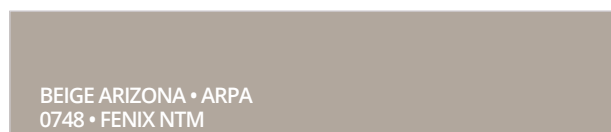
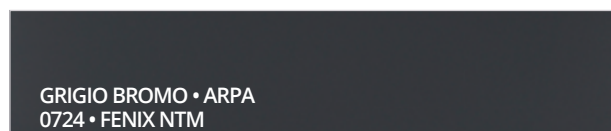

*

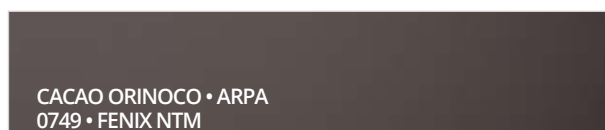

*

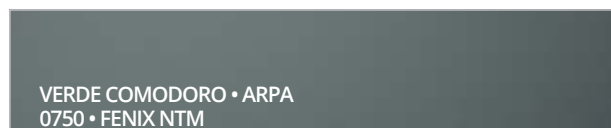

*



*



*



*



Decorativo disponibile in sp. 59mm

59mm decorations available • Décors disponibles en 59mm • Decoraciones disponibles en 59 mm

13-19-39-59 mm

Laminati FENIX

FENIX Laminate • Stratifié FENIX • Laminado FENIX



NERO INGO Black Core • ARPA
0720 • FENIX NTM

Piani di lavoro, penisole e fianchi

Worktops, double faced and side panels • Plans de travail, plans de Travail double-face et jambages • Encimeras una cara, doble cara y laterales

Sp. 12-18-38-58 mm + Laminato

Th. 12-18-38-59 mm + Laminate

ÉP. 12-18-38-59 mm. + stratifié

ESP. 12-18-38-59 mm + laminado

Dimensioni massime: 1280mm - 4150mm

Maximum dimensions: 1280mm - 4150mm

Dimensions maximales : 1280mm - 4150mm

Dimensiones máximas: 1.280mm - 4.150mm

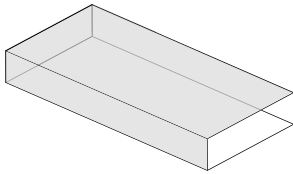

Piano di lavoro • Profilo anteriore in ABS • Profilo posteriore di protezione

Worktop • ABS front profile • Protective rear profile

Plan de travail • Chant avant ABS • Chant arrière protection

Encimera • Canto delantero ABS • Canto trasero de protección

P/R	W	U. M.
PT40-19/39	0-400	M/L.
PT65-19/39	401-650	M/L.
PT90-19/39	651-900	M/L.
PT120-19/39	901-1200	M/L.
PT128-19/39	1201-1280	M/L.

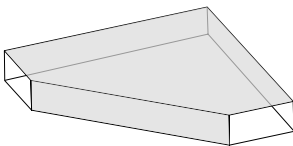

Angolo • Profilo anteriore in ABS • Profilo posteriore di protezione • Assemblaggio

Corner top • ABS front profile • Protective rear profile • Assemblages

Plan d'angle • Chant avant ABS • Chant arrière protection • Assemblages

Plano de esquina • Canto delantero ABS • Canto trasero de protección • Ensamblajes

P/R	W	U. M.
PTA90-19/39	900x900	U
PTA95-19/39	950x950	U
PTA105-19/39	1050x1050	U

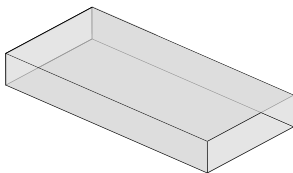

Penisola "interno = esterno"

Profilo anteriore e posteriore in ABS

Double-faced worktop

2 ABS Profiles

Plan de travail double face

2 Chants ABS

Encimera doble cara

2 cantos ABS

P/R	W	U. M.
PTDF40-19/39	0-400	M/L.
PTDF65-19/39	401-650	M/L.
PTDF90-19/39	651-900	M/L.
PTDF120-19/39	901-1200	M/L.
PSTDF 128- 19/39	1201-1280	M/L.

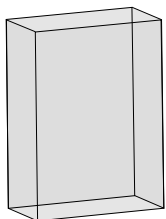

Fianco "interno = esterno"

Profilo anteriore e posteriore in ABS

Double-faced side panel

2 ABS Profiles

Jambage double face

2 Chants ABS

Lateral doble cara

2 cantos ABS Plaqués

P/R	W	U. M.
PTDF40-19/39	0-400	M/L.
PTDF65-19/39	401-650	M/L.
PTDF90-19/39	651-900	M/L.
PTDF120-19/39	901-1200	M/L.
PSTDF 128- 19/39	1201-1280	M/L.

P/R = Referenza Prodotto / Product Reference / Référence Produit / Referencia Producto

W = Profondità / Width / Profondeur / Fondo

U.M. = Unità di Misura / Unit of Measure / Unité de Mesure / Unidad de Medida



Lavorazioni speciali

Worktop machining options

Options d'usinage plans de travail

Opciones de mecanización de encimeras

Laminati HPL

HPL laminate

Stratié HPL

Laminado HPL

19-39-59 mm

Laminati HPL con poro sincronizzato

HPL Laminate synchronised pores

Stratifié HPL pores synchronisés

Laminado HPL poro sincronizado

19-39 mm

Laminati FENIX

FENIX Laminate

Stratié FENIX

Laminado FENIX

19-39-59 mm

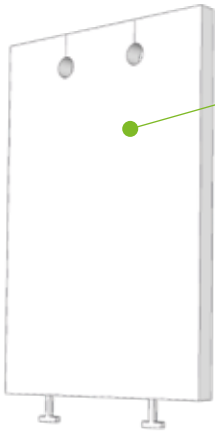

UJ

ABS 3 lati + protezione inferiore + piedini
 3 sides ABS + bottom protection edge + feet
 3 chants ABS + Chants de protection bas + pieds
 3 Cantos ABS + Canto de proteccion inferior
 Perforacion Herraje de fijacion alto Patas de ajuste inferior

U.M. Unit

UPS

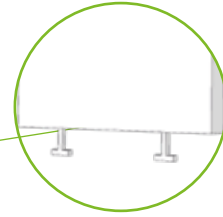

Piedini regolabili
 Adjustment feet
 Usinage des pieds
 Solo instalacion de patas

U.M. Unit

Il prezzo include la lavorazione del piano di lavoro, indicarne la posizione

The price includes worktop machining, please consider its positioning

Usinage du P.D.T compris dans le prix merci de le positionner

El precio incluye mecanizados, indique posicion

PD

Taglio Fem/Dx
 R/Fem cut
 Déc. Plat D.
 Corte Dcha/Hembra

BG

Taglio Mas/Sx
 L/Male cut
 Déc. Bout G
 Corte lz/macho

BD

Taglio Mas/Dx
 R/Male cut
 Déc. Bout D.
 Corte D/macho

PG

Taglio Fem/Sx
 L/Fem cut
 Déc. Plat G
 Corte lzda Hembra

UJ

U.M. Unit

D1

Taglio ang. var Dx
 Variable angle R cut
 Déc. Angle variable D.
 Corte angulo Dcho variable

D2

Taglio ang. var Sx
 Variable angle L cut
 Déc. Angle variable G.
 Corte angulo lzdo variable

D4

Taglio Sx
 L cut
 Déc. D
 Corte lzdo recto

D3

Taglio Dx
 R cut
 Déc. G
 Corte Dcho recto

U.M. Unit

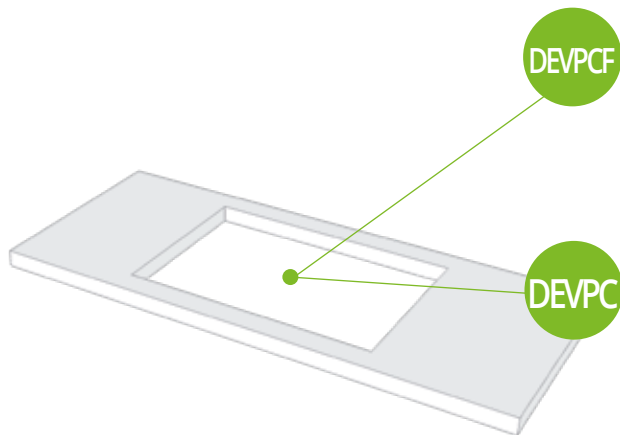

DEVPCF Foro lavello filo top*
 Recessed Sink Cut*
 Pose à fleur plaque ou évier*
 Corte fregadero o placa enrasado*

U.M. Unit

DEVPC Foro lavello e piano cottura
 Sink and Hob hole cuts
 Coupe évier, Plaque de Cuisson
 Corte fregadero, placa de cocción

Raggio minimo
 Minimum radius / Rayon min / Radio mínimo: 5mm

U.M. Unit

* Lavorazione esclusiva per laminati FENIX
 Exclusive machining for FENIX laminates / Usinage exclusif pour stratifiés FENIX / Mecanizacion exclusiva para laminados FENIX

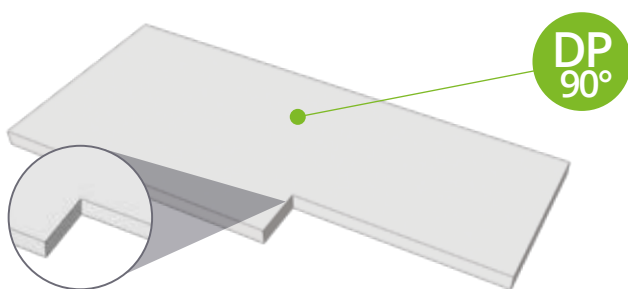

DP 90° Scasso pilastro a 90° + ABS
 Corner cut 90° + ABS
 Coupe d'angle 90° + ABS
 Corte angular 90° canteado ABS

U.M. Unit

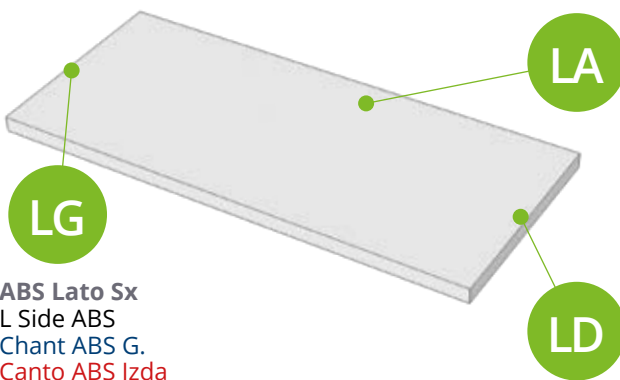

LA ABS Posteriore
 Rear Side ABS
 Chant ABS arrière
 Canto ABS Posterior

U.M. M/L

LG ABS Lato Sx
 L Side ABS
 Chant ABS G.
 Canto ABS Izda

LD ABS Lato Dx
 R Side ABS
 Chant ABS D.
 Canto ABS Dcha

U.M. Unit

U.M. Unit

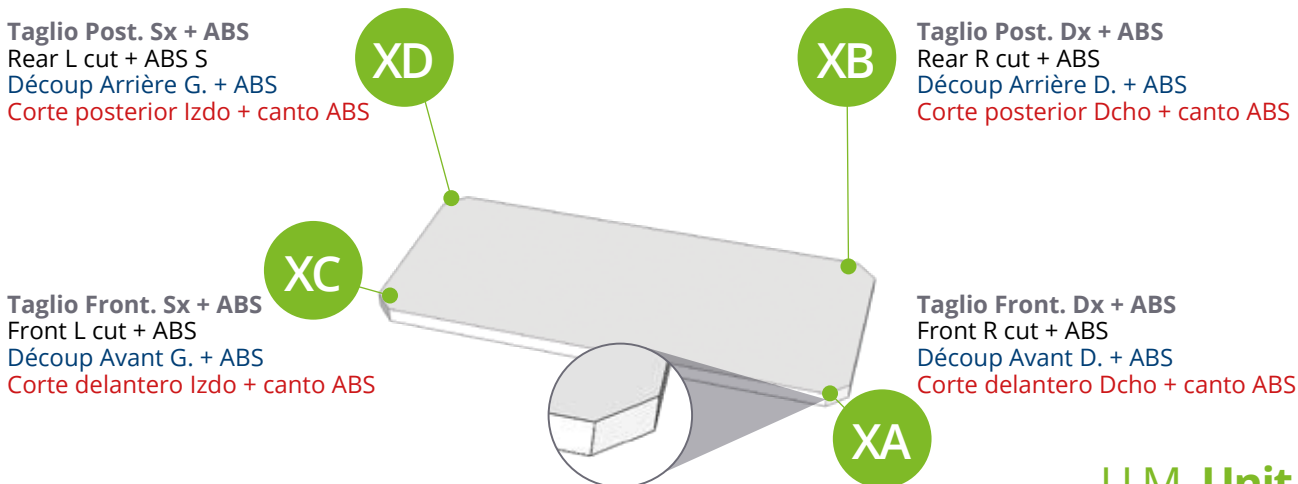

XD Taglio Post. Sx + ABS
 Rear L cut + ABS S
 Découp Arrière G. + ABS
 Corte posterior Izdo + canto ABS

XB Taglio Post. Dx + ABS
 Rear R cut + ABS
 Découp Arrière D. + ABS
 Corte posterior Dcho + canto ABS

XC Taglio Front. Sx + ABS
 Front L cut + ABS
 Découp Avant G. + ABS
 Corte delantero Izdo + canto ABS

XA Taglio Front. Dx + ABS
 Front R cut + ABS
 Découp Avant D. + ABS
 Corte delantero Dcho + canto ABS

U.M. Unit

U.M. = Unità di Misura / Unit of Measure / Unité de Mesure / Unidad de Medida

Arrot. Post. Sx + ABS
 Rear L round cut + ABS
 Coin arrondi arrière G. + ABS
 Redondeo posterior Izdo + canto ABS



Arrot. Post. Dx + ABS
 Rear R round cut + ABS
 Coin arrondi arrière D. + ABS
 Redondeo posterior Dcho + canto ABS

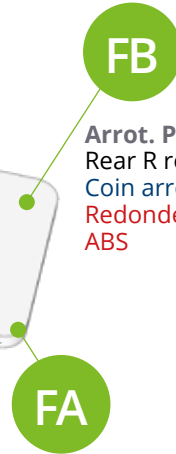

Arrot. Front. Sx + ABS
 Front L round cut + ABS
 Coin arrondi avant G. + ABS
 Redondeo delantero Izdo + canto ABS



Arrot. Front. Dx + ABS
 Front R round cut + ABS
 Coin arrondi avant D. + ABS
 Redondeo delantero Dcho + canto ABS

Raggio minimo / Minimum radius / Rayon min / Radio mínimo: 30mm

U.M. Unit

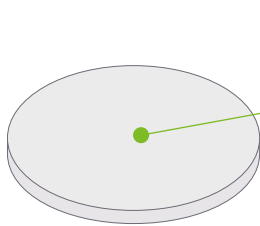

FH
Tavolo circolare + ABS
 Round Table + ABS
 Table ronde + ABS
 Masa redonda + canto ABS

U.M. Unit

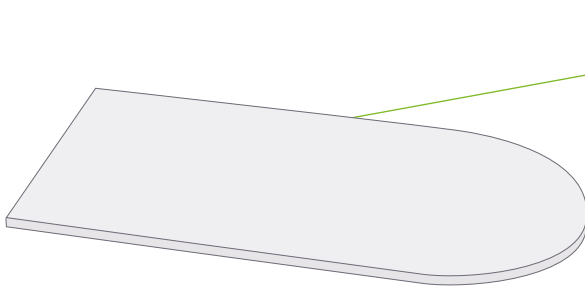

FG
Tavolo semicircolare + ABS
 Half round Table + ABS
 Table demi-rond + ABS
 Mesa semiredonda + canto ABS

U.M. Unit

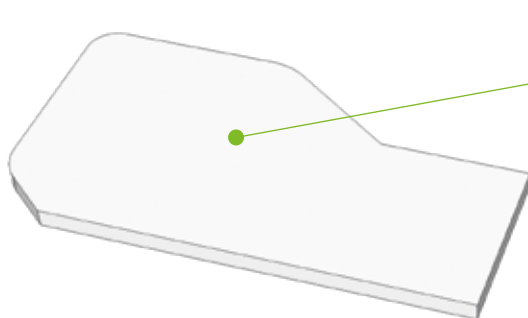

DSFL
Forma Speciale + ABS
 Custom Shape + ABS
 Forme spéciale + ABS
 Forma especial + canto ABS

U.M. Unit

U.M. = Unità di Misura / Unit of Measure / Unité de Mesure / Unidad de Medida

Schienali FENIX

FENIX laminate wall panels • Crédences stratifié FENIX • Frontal de pared laminado FENIX

1 o 2 facce rivestite sp. 12mm (Non idrofugo) + Laminato

1 or 2 facets th. 12mm (Not waterproof) + Laminate

1 ou 2 faces ép. 12mm (Pas hydrofuge) + stratifié

1 ó 2 caras esp. 12mm (No hidrófugo) + laminado

Minimo fatturabile 0,15 m²

Minimum order 0,15 m² / Minimum de facturation 0,15 m² / Facturación mínima 0,15 m²



1 Faccia decoro

1 Decorated facet / 1 Face décor / 1 Cara decorativa

Controbilanciante bianco

White counterbalanced facet / Contrebalancée Blanc / Contracara Blanca

4 profili ABS

4 ABS profiles / 4 Chants ABS plaqués / 4 Cantos ABS

PR1-13 P/R

1280x4150 MAX. DIM.

13 TH

U.M. M2

2 Facce decoro

2 Decorated facets / 2 Face décor / 2 Caras decorativas

4 profili ABS

4 ABS veneered profiles / 4 Chants ABS plaqués / 4 Cantos ABS

PR2-13 P/R

1200x4150 MAX. DIM.

13 TH

U.M. M2

Lavorazioni speciali

Machining options

Options d'usinage

Opciones de mecanización

Laminati HPL

HPL laminate • Strafié HPL

• Laminado HPL

Laminati FENIX

FENIX Laminate • Stratifié FENIX

• Laminado FENIX

13 mm

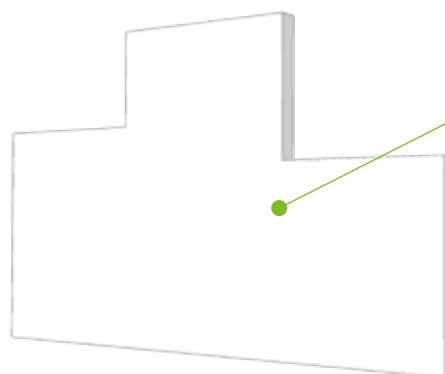

DSCR

Forma Speciale + ABS

Custom Cut + ABS

Déc. Spécial + ABS

Corte especial + canto ABS

U.M. Unit

P/R = Referenza Prodotto / Product Reference / Référence Produit / Referencia Producto

MAX. DIM. = Dimensioni massime / Max dimensions / Dimension maxi / Dimensión máx

TH = Spessore / Thickness / Épaisseur / Espesor

U.M. = Unità di Misura / Unit of Measure / Unité de Mesure / Unidad de Medida



Topstar S.p.A.
Via dell'industria 2 - 61024 Mombaroccio (PU)
Tel. +39 0721 471 222 / 223 - Fax. +39 0721 471 224
info@topstarpostforming.com